



Crossfit

008.001.009.001

blue rabbit



© 2019

Blue Rabbit 2.0 - Hemelrijken 8 - B-2890 St-Amands - Belgium.
Copyrighted material - Do not reproduce under penalty of law.

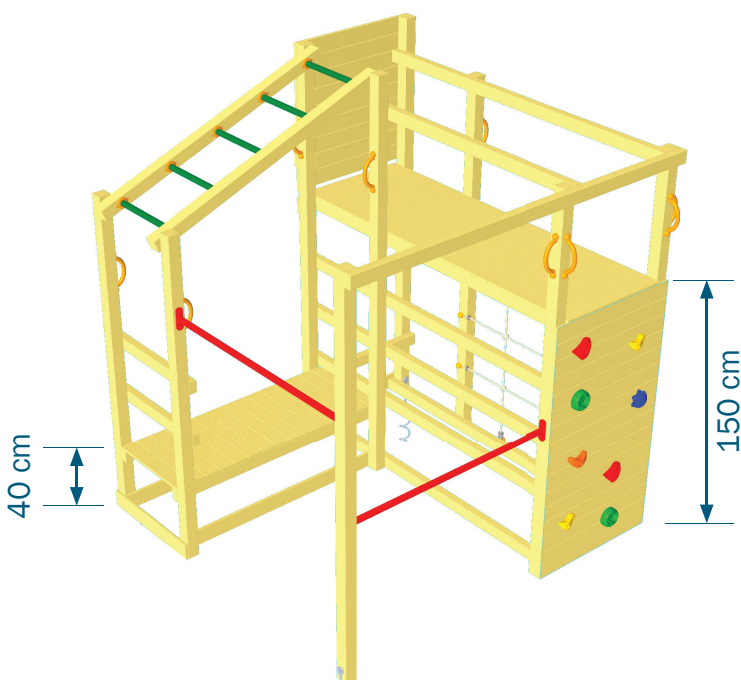
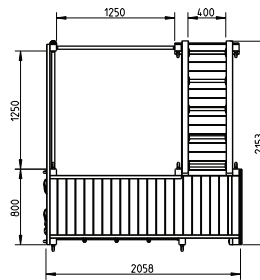
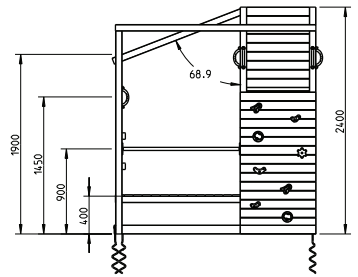
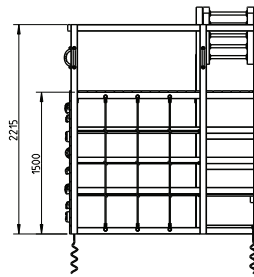
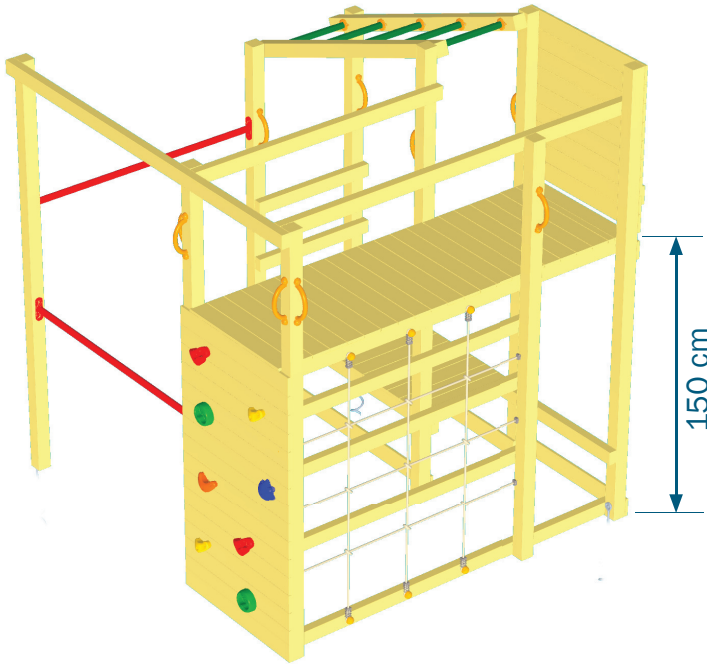

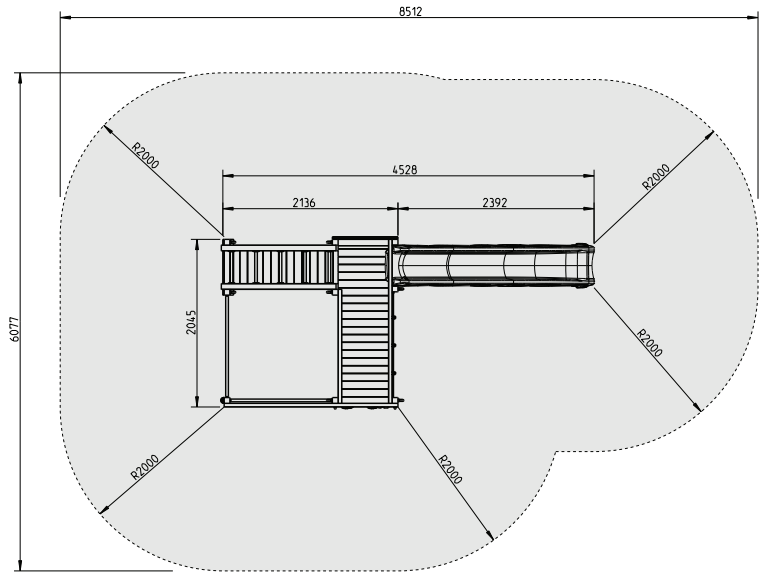
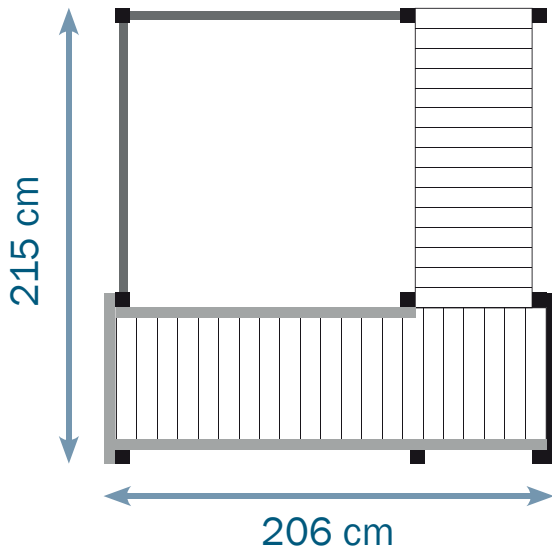

			@challenger 008.003.007.001 	
			@swing 008.003.005.001 	
Crossfit 008.001.009.001 	Ⓐ	Ⓐ	X	I

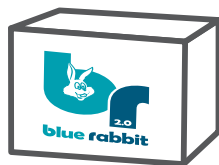

126 x 30 x 11 cm



13,5 kg

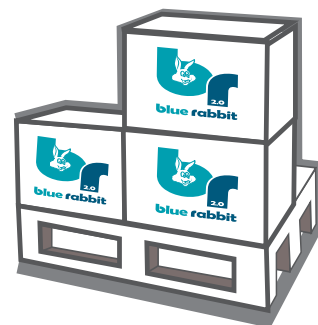

















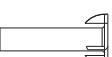

25











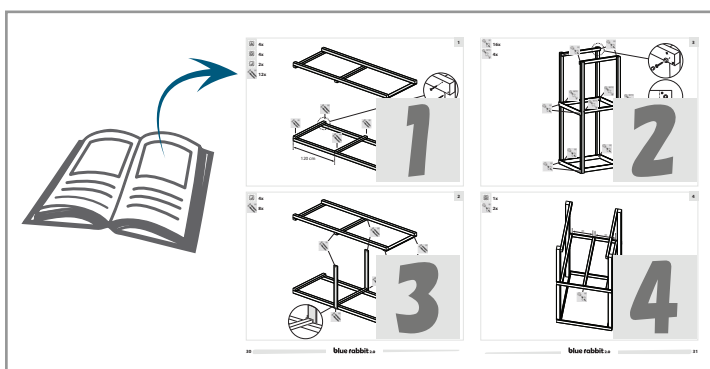
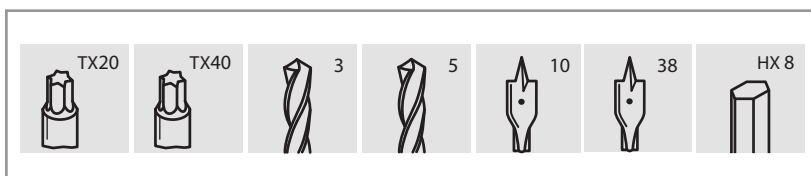





126 x 80 x 81 cm



363 kg

 30 mm - 45 mm - 80 mm	3x  70 mm
 45 mm - 80 mm	8x  25 mm
 50 mm - 80 mm	8x  40 mm
8x  70 mm	 60 mm
4x  90 / 110 mm	 60 mm
4x  130 / 170 mm	 60 mm
3x  40 mm	 30 mm
3x 	2x 
9x 	8x 
5x 	1x 



- 3x** **A** min 68 mm | max 90 mm  240 cm
min 68 mm | max 90 mm
- 4x** **B** min 68 mm | max 90 mm  221 cm
min 68 mm | max 90 mm
- 2x** **C** min 68 mm | max 90 mm  190 cm
min 68 mm | max 90 mm
- 2x** **D** min 68 mm | max 90 mm  150 cm
min 68 mm | max 90 mm
- 2x** **E** min 68 mm | max 90 mm  min 212 / max 214 cm
min 32 mm | max 50 mm
- 8x** **F** min 68 mm | max 90 mm  min 199 / max 210 cm
min 32 mm | max 50 mm
- 2x** **G** min 68 mm | max 90 mm  min 138,5 / max 143 cm
min 32 mm | max 50 mm
- 2x** **H** min 68 mm | max 90 mm  min 67 / max 76 cm
min 32 mm | max 50 mm
- 2x** **I** min 95 mm | max 145 mm  min 138,5 / max 143 cm
min 15 mm | max 22 mm
- 20x*/28x**** **J** ** min 95 mm | * max 145 mm  80 cm
min 15 mm | max 22 mm
- 1x** **K** min 95 mm | max 145 mm  min 67 / max 76 cm
min 15 mm | max 22 mm
- 15x*/22x**** **L** ** min 95 mm | * max 145 mm  min 62 / max 66,5 cm
min 15 mm | max 22 mm
- 10x*/15x**** **M** ** min 95 mm | * max 145 mm  min 53,5 / max 58 cm
min 15 mm | max 22 mm

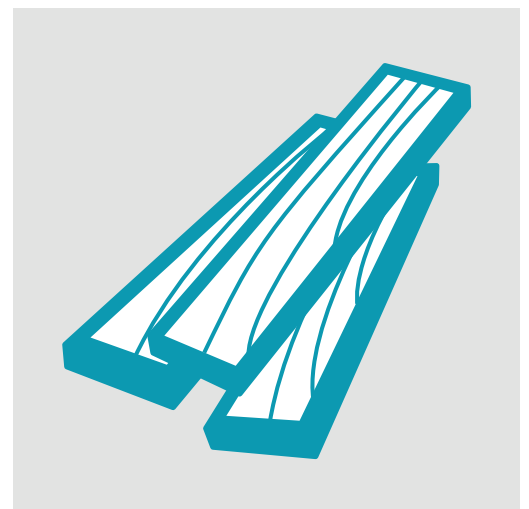



Blue Rabbit 2.0®
Hemelrijken 8
B-2890 Sint-Amands
BELGIUM

info@bluerabbit.be

www.bluerabbit.be