

Climbers – Cone Climber 2.4m

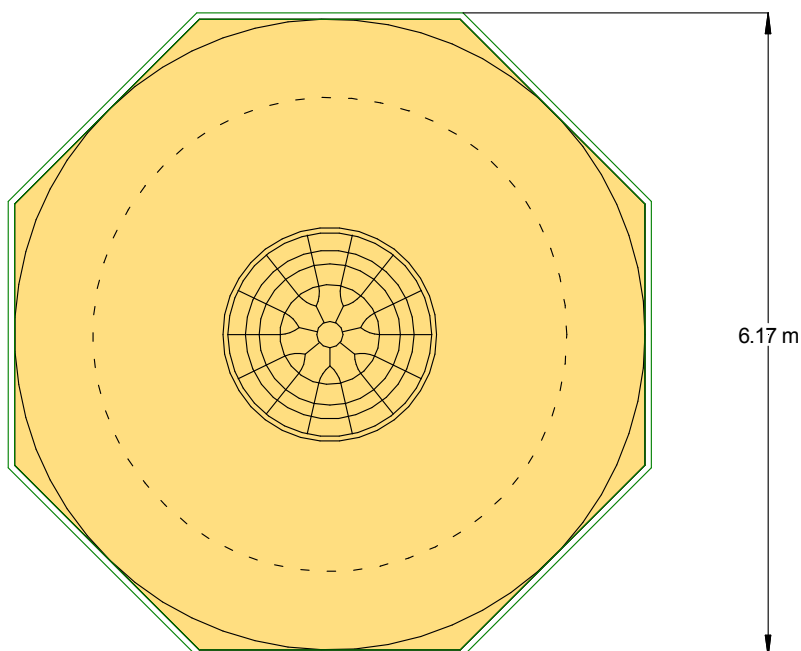
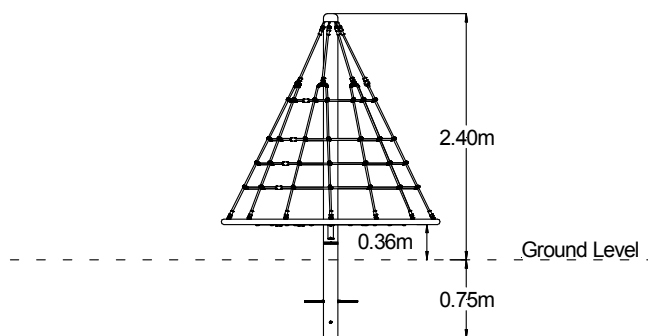

Technical Information

Equipment Dimensions

Length / Width / Height **2.05m x 2.05m x 2.4m**

Surfacing and Area Required

Minimum Space Required L/W/H **6.17m x 6.17m x 3.2m**

Max Gradient of Ground **1 in 50**

Free Height of Fall **1.5m**

Impact Area **30.33m²**

Loosefill (Bark / Cushionfall / Sand) at 250mm **8m³**

Grasslok Tiles **29m²**

Installation Information

Overall Weight **130kg**

Heaviest Part **80kg**

Largest Part **2.1m x 2.1m x 0.2m**

Longest Part **3.2m**

Concrete Required **0.5m³**

TUV CERTIFIED TO BS EN 1176