

Encounter 6

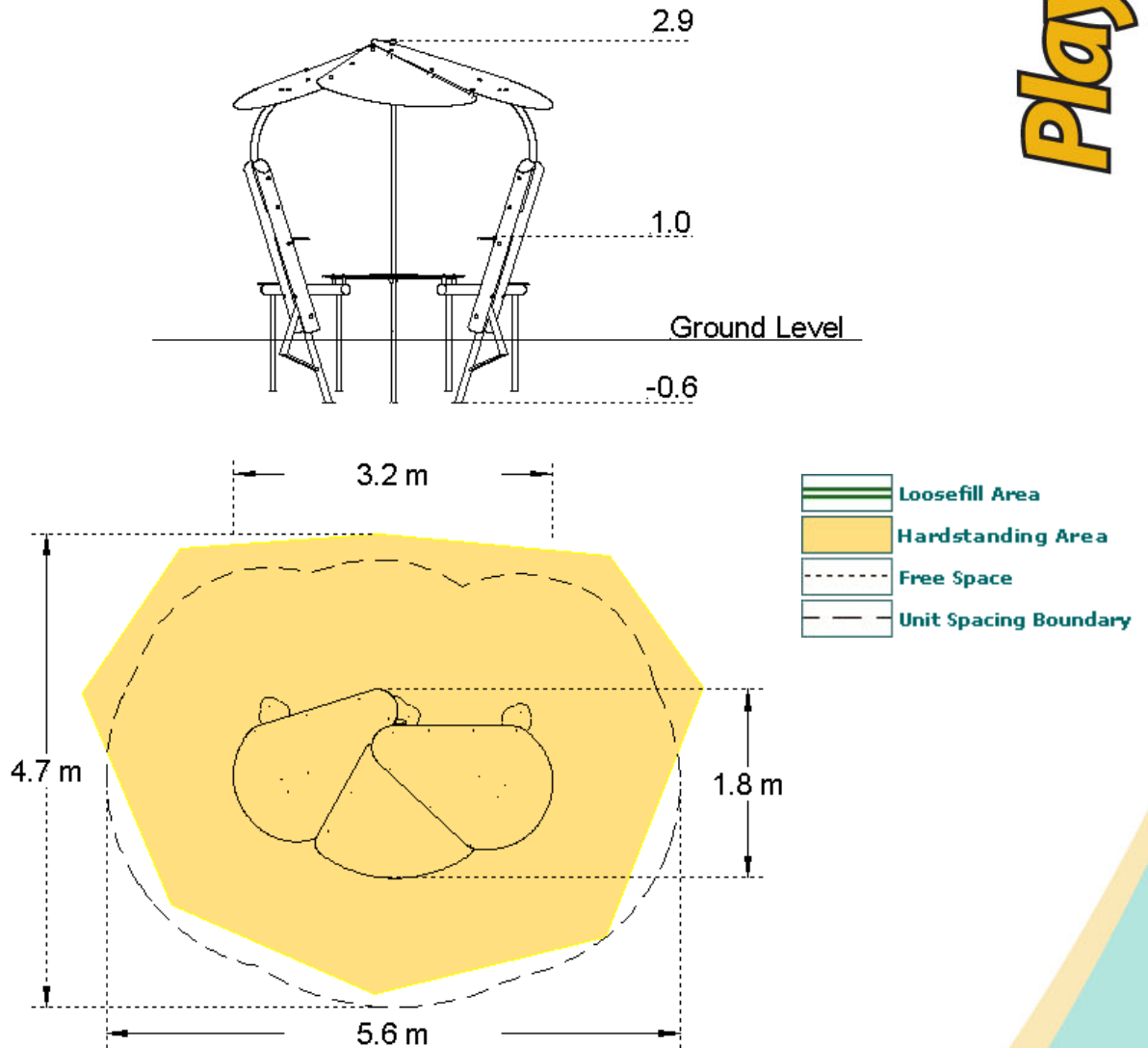

Technical Information	
Equipment Dimensions	
Length / Width / Height	1.8 x 3.2 x 2.9m
Surfacing and Area Required	
Minimum Space Required L/W/H	4.7 x 5.6 x 4.1m
Max Gradient Of Ground	1 in 30
Free Height Of Fall	-
Suggested Hardstanding Area	20.15 m ²
Loosefill At 150mm	-
Bark / Cushionfall / Sand	-
Grasslok Tiles	-
Installation Information	
Overall Weight	253 kg
Heaviest Part	28 kg
Largest Part	2.0 x 1.3 x 0.02m
Longest Part	3.5m
Concrete Required	0.57 m ³