

Big City Plus - Antwerp Plus



Code – BC/ANT*2

Age

5-12 years

Materials

Stainless Steel

Nylon Steel Cored Rope

Compact Grade Laminate
(CGL)

Various Plastic Mouldings

LLDPE Slide

A junior modular tower system comprising of:

- Square Tower (1.5m)
- Triangular Tower (1.1m)
- Slide (1.5m)
- Twisted Climbing Net (1.5m)
- Fireman's Pole (1.1m)
- Slide Climber (1.1m)
- Inclined Hoop Bars

Technical Information

Equipment Dimensions

Length / Width / Height **5.6m x 5.4m x 3.1m**

Surfacing and Area Required

Recommended Minimum Space
L/W/H **9.5m x 8.6m x 4.3m**

Max Gradient of Ground **1 in 50**

Free Height of Fall **1.5m**

Impact Area **42.47m²**

Synthetic Area
(i.e. EPDM / Wet Pour / Synthetic Grass etc.) **42.06m²**

Loosefill at 250mm **14m³**

(i.e. Bark / Cushionfall / Sand)

GrassLok Tiles **59m²**

Installation Information

SGF

SF (if different)

Installation Time **2 Persons 14 Hours**

Overall Weight **512kg**

Heaviest Part **37kg**

Largest Part **3.1m x 0.4m x 0.4m**

Longest Part **3.1m**

Concrete Required **0.72m³** **1.09m³**

Certified to ASTM F1487

[Click here for more information & downloads](#)



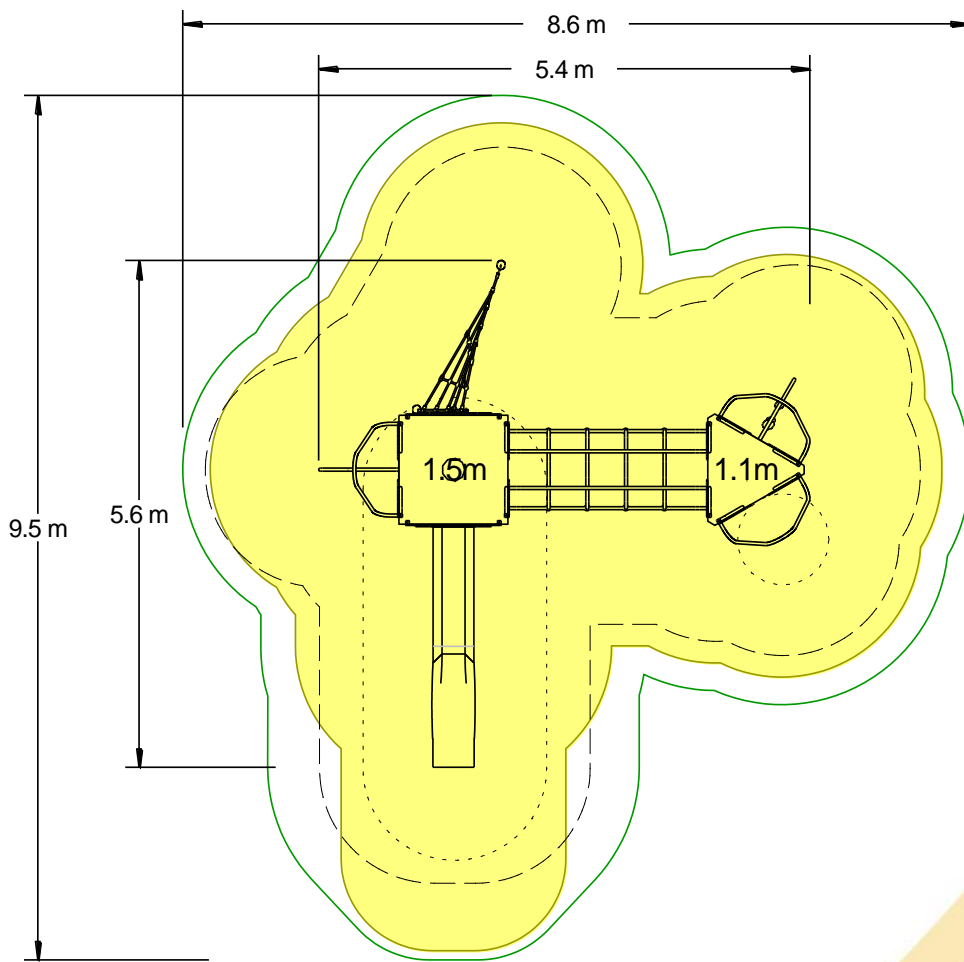
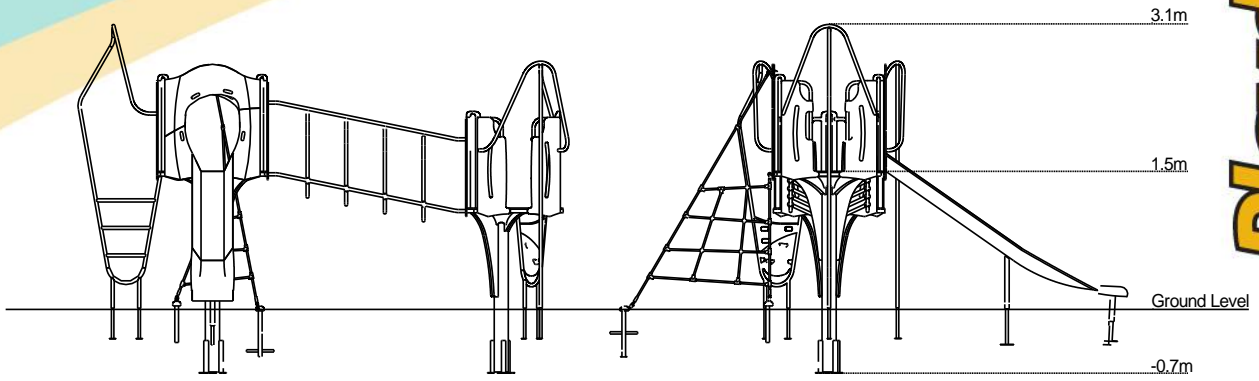

- Recommended Minimum Space
- Impact Area
- Free Space
- Unit Spacing Boundary

[Click here for more information & downloads](#)